

200-006

DGUV Information 200-006

Training for work on vehicles with high voltage systems



Imprint

Published by:
Deutsche Gesetzliche
Unfallversicherung (DGUV)

Glinkastraße 40
10117 Berlin, Germany
Tel.: +49 30 288763800
Fax: +49 30 288763808
E-Mail: info@dguv.de
Internet: www.dguv.de

DGUV expert committees for the energy, textile, electrical and media products sectors and for woodworking and metalworking.

With the involvement of the German automotive manufacturers, the Zentralverband Deutsches Kraftfahrzeuggewerbe e. V., and DKE Deutsche Kommission Elektrotechnik Elektronik Informationstechnik im DIN und VDE.

This is the English translation of the german informative publication “Qualifizierung für Arbeiten an Fahrzeugen mit Hochvoltssystemen”, April 2012. The German original version is obligatory.

April 2012 edition

BGI/GUV-I 8686. Available from your responsible accident insurance institution or from www.dguv.de/publikationen.

Training for work on vehicles with high voltage systems

Contents

	Page
Foreword	6
I. Scope	7
II. Definitions	8
III. Electrical hazards presented by high voltage on vehicles	11
1. Electrical work on the HV systems of vehicles	11
2. Responsibility	14
3. Risk assessment	21
IV. Training for work in development and manufacture	25
1. Qualification stages for work to be performed prior to the start of production	25
1.1 General	25
1.2 Qualification for Stage 1: non-electrical work	27
1.3 Qualification for Stage 2: electrical work	28
1.4 Qualification for Stage 3: live electrical work	31
2. Training for work relating to production and commissioning during the manufacturing process	35
2.1 Assembly	35
2.2 Commissioning following assembly	35
2.3 Electrical tests	37
V. Training for work on series production vehicles	38
1. Operation of vehicles	38
2. Non-electrical work	39
3. Electrical work	40
3.1 Service workshops for vehicles with intrinsically safe HV systems, particularly passenger cars	41
3.2 Service workshops for vehicles without intrinsically safe HV systems, particularly commercial vehicles	43
3.3 Work on live energy storage devices and at test stations	48

	Page
4. Accident assistance	50
5. Scrappage	51
Annex 1: Model risk assessment	52
Annex 2: Flow chart: need for training for work in development, on test rigs (isolated)....	53
Annex 3: Flow chart: need for training for work development, on test rigs (live)	54
Annex 4: Topics covered by training for persons without prior electrical knowledge but with technical training	55
Annex 5: Topics covered by training for persons without prior electrical knowledge in the automotive sector	61
Annex 6: Topics covered by training for skilled electrical persons in the low voltage sector	65
Annex 7: Flow chart: need for training for service work on vehicles with intrinsically safe HV systems	67
Annex 8: Topics covered by training for persons with prior electrical knowledge in the automotive sector for work in service workshops on vehicles with intrinsically safe HV systems	68
Annex 9: Flow chart: need for training for service work on vehicles with non-intrinsically safe HV systems	71
Annex 10: Model certificate of attendance for persons who have received electrical instruction in inherently safe HV systems in vehicles	72
Annex 11: Model certificate for an expert in high voltage (HV) vehicle systems for work in service workshops on vehicles with intrinsically safe HV systems	73
Regulations, codes, literature	75
Authors	77
List of illustrations	78

Foreword

The growing use of voltages above 30 V AC and 60 V DC in automotive technology owing to fuel cells, hybrid technology and electric vehicles gives rise to an electrical hazard in the form of electric shock and arcing during work on vehicles. This in turn results in a responsibility for the employer to train his employees further such that they are able to assess pending electrical work, identify possible hazards, and define suitable protective measures.

The present informative publication contains instructions for the employer/superior on how, based upon the risk assessment (see **Annex 1** for a model risk assessment), the electrical hazards can be identified (red tab) and the need for training determined for work in:

- Research and development (green tab)
- Service workshops (yellow tab).

This document does not apply to mounted and fixed machinery on vehicles in accordance with the European Machinery Directive such as that fitted to refuse collection vehicles or mounted cranes.

I. Scope

The present informative publication governs the training of persons carrying out work on vehicles with high voltage systems and on the components of such vehicles.

It contains instructions for the employer/superior on how, based upon the risk assessment, the electrical hazards is to be identified and the need for training determined for the following work:

- In research and development;
- In the production and manufacturing process;
- In service workshops.

This document is not applicable to training for electrical work on railbound vehicles or on mounted or fixed equipment fitted to vehicles and falling within the scope of the European Machinery Directive.

The information in this document can be applied by analogy to electrical work on other vehicles, such as recreational water craft.

II. Definitions

1. Skilled electrical person

A skilled electrical person is a person who owing to his or her skilled training, knowledge and experience and familiarity with the relevant standards is able to assess the work with which he or she is tasked and to recognize possible hazards.

2. Responsible skilled electrical person

A responsible skilled electrical person is a skilled electrical person who assumes technical and supervisory responsibility and is tasked with doing so by the employer. With regard to observance of the electrical safety provisions within the area for which they are given responsibility, the responsible skilled electrical person must not be subject to the authority of persons who are not themselves responsible skilled electrical persons.

3. Control and supervision

Control and supervision encompass all tasks required for the safe and proper performance of work on electrical systems and equipment by employees who do not possess the knowledge and experience of a skilled electrical person. The control and supervision of electrical work may be assumed only by a skilled electrical person.

4. Person who has received electrical instruction

A person who has received electrical instruction is a person who has been instructed and if necessary trained on the job by a skilled electrical person regarding the work with which they are tasked and who has been familiarized with the necessary protective equipment and protective measures.

5. Operation of electrical systems

The operation of electrical systems encompasses all tasks which are necessary for an electrical system to function, such as switching, controlling, monitoring, maintenance – including testing and servicing – and both electrical and non-electrical work.

6. User operation

User operation constitutes a part of operation and encompasses observation, control, regulation and switching of the electrical system.

7. Work

Work is an electrical or non-electrical task of any form during which the possibility exists of an electrical hazard.

8. Electrical work

Electrical work comprises tasks on or involving electrical systems or within their hazard area, such as trialling and measurement, repair, replacement of components, modification, extension, erection and testing.

9. High voltage (HV)

In the automotive sector, particularly in hybrid and fuel cell technology and on electric vehicles, high voltage comprises voltages $> 60 \text{ V}$ and $\leq 1500 \text{ V DC}$ and $> 30 \text{ V}$ and $\leq 1000 \text{ V AC}$.

10. Electrical hazards

Electrical hazards exist during work on HV systems when the voltage between the live components is greater than 25 V AC or 60 V DC and the short-circuit current where work is being performed exceeds the value of 3 mA AC or 12 mA DC or the energy exceeds 350 mJ .

11. Live work on the HV system

In the context of this document, live work on HV systems is any work on the HV system during which an employee's body or items (tools, devices, equipment or apparatus) come into contact with live parts, or work during which the non-live state is not assured.

12. Vehicle with an intrinsically safe HV system

A vehicle with an intrinsically safe HV system is one on which technical measures on the vehicle assure full protection against electric shock from and arcing on the HV system.

This is achieved in particular by:

- Safe disconnection by technical means of the HV system and automatic discharge of energy storage devices where present before live parts can be touched.
- Cable connections involving arc-proof plug-and-socket arrangements rather than by means of threaded connections.
- Safe disconnection when the covers of the HV system are removed.

13. SoP (Start of Production)

Start of production represents the beginning of series production of vehicles, i. e. they are assembled in accordance with standardized work procedures. The development phase and manufacture of prototypes and pilot series vehicles has been completed at this stage.

14. Vehicles

Vehicles in this context are land vehicles which are moved operationally by machine force or are towed.

Examples of land vehicles are motor cars and trucks, buses, trailers, agricultural machinery, excavators, loaders, non-railbound excavation machinery, mobile cranes, industrial trucks, ground vehicles used in aviation such as tractors, transport vehicles, vehicles for the loading and unloading of aircraft, supply and waste disposal vehicles, and two-wheeled vehicles.

15. TP (teaching period)

A teaching period in this context has a duration of 45 minutes.

Electrical hazards presented by high voltage on vehicles

1. Electrical work on the HV systems of vehicles

Electrical work may not be started until protective measures have been taken against electric shock, short-circuits and fault arcs. More detailed information on the hazards presented by electric current can be found in informative publication BGI 548 (in German) governing skilled electrical persons.

Work may not generally be performed on live parts of electrical systems and equipment. For this purpose, these systems and equipment must be placed in the non-live state prior to and for the duration of the work.

This is achieved by the observance of five safety rules.

Five safety rules

Prior to starting work

- Isolate
- Safeguard reconnection against
- Verify the non-live state
- Earth and short-circuit
- Shroud or safeguard adjacent live parts

These five rules for safe work are vital. The rules must generally be observed in the order stated.

The five safety rules are generic for all electric power systems, irrespective of the actual voltage level. Certain lower constraints may apply to systems with rated voltages of up to 1000 V. The first three rules must be applied during work on the HV system. Whether the fourth and fifth rules must also be applied must be determined on a case-by-case basis.

In a given case, the requirement for application of the five safety rules on vehicles with HV systems can for example be met as follows (as determined by the manufacturer concerned):

Rule 1: Isolate

- Switch off the ignition,
- Withdraw service plug/switch off main battery switch,
- Remove fuses,
- Withdraw plug for interlock/pilot/monitoring circuit,
- Disconnect from the stationary grid (e.g. charging plug).



Figure 1:
Service plug

Rule 2: Safeguard against reconnection

- Remove the ignition key and prevent unauthorized access to it,
- Store the service plug against unauthorized access/safeguard the main battery switch against reconnection, for example by means of a lock or lockable shroud,
- Observe further internal company provisions and the manufacturer's information.



Figure 2:
Examples of
safeguarding against
reconnection

Rule 3: Verify the non-live state

Residual charges (for example voltages in intermediate circuits) may be present even when the HV voltage has been disconnected.



Figure 3:
Verification of the non-live state

The non-live state of the HV system must therefore always be verified before work is begun!

In accordance with German accident prevention regulation BGV/GUV-V A3, "Electrical installations and equipment", the non-live state may be verified only by a skilled electrical person or a person who has received electrical instruction. The provisions of the vehicle manufacturer must be observed for verification of the non-live state.

Suitable voltage testers or test apparatus specific to the manufacturer must be used. Test apparatus is suitable in particular when it has been tested against the necessary criteria by a test body and found to be suitable. Multimeters have led to a high rate of accidents on high-energy parts of apparatus; they are not therefore suitable.

Other mobile instruments are suitable for verifying the non-live state when they also satisfy the provisions for voltage detectors to DIN VDE 0682-401 Part 3, "Voltage detectors: Two-pole low-voltage type". Where standard commercial voltage testers are used, ensure that they are suitable for the type and level of the voltage to be measured and that they are fully serviceable. Their full serviceability must be determined before verification of the non-live state. The non-live state must be verified on

all conductive parts which could be live. Until the non-live state has been verified, the system is to be assumed to be live.

Completion of the work

Once the work has been completed, the safety rules are lifted again. All tools, auxiliary material and other equipment must first be removed from the site of the work and the hazard area. Guards removed before the start of work must be properly replaced and warning signs removed.

2. Responsibility

The requirements governing the specialist qualification of persons carrying out electrical work in Germany are set out in a number of regulations and VDE provisions, in particular:

- The German occupational safety and health act,
- Accident prevention regulation BGV/GUV-V A3, “Electrical installations and equipment“,
- DIN VDE 0105-100 “Operation of electrical installations“,
- DIN VDE 1000-10 “Requirements for persons working in a field of electrical engineering“.

Employers/superiors

The primary and highest duty of accident prevention in a company always rests with the employer. The employer must ensure that electrical systems and equipment are erected, modified and maintained only by a skilled electrical person or under the control and supervision of a skilled electrical person, and in accordance with good electrical practice.

The employer is responsible for:

- Provision of and decisions concerning funds,
- Selection of superiors,
- Fundamental decisions concerning safety policy, safety organization, safety facilities.

Examples of the employer's duties include:

- Producing risk assessments and defining protective measures.
- Ensuring that only adequately qualified personnel perform work on the HV systems of vehicles.
- Generating work instructions for work on HV systems.
- Organizing the area of electrical work.
- Specifying the scope of tasks and competencies of the personnel in consideration of the tasks to be performed.

Certain duties of the employer can be delegated to superiors within the company. The duties may be delegated on a case-by-case or on a workplace basis, for example by a job description.

Accordingly, superiors may be responsible for:

- Performance of OSH measures,
- Generation of OSH-related instructions,
- Motivation to observe OSH,
- Supervision and monitoring,
- Reporting to the next senior superior,
- Aversion of hazards on a case-by-case basis.

All superiors must ensure that, for the intended tasks, their staff:

- possess the necessary specialist qualifications,
- are physically and mentally suitable.

Section 7, concerning competence for tasks, of the BGV/GUV-V A1 accident prevention regulation governing principles of prevention states as follows (unofficial translation):

- (1) Where insured persons are charged with tasks, the employer must consider, with regard to the nature of the tasks concerned, whether the insured persons are competent to observe the health and safety provisions and measures to be followed during completion of the task.*
- (2) The employer must not assign tasks to insured individuals who are evidently not able to carry them out without danger to themselves or others.*

In order to verify competence, the employer may consider vocational qualifications, vocational experience already gained, other evidence (certificates, etc.), knowledge, and particular training and instruction. In addition, each employee must be given an adequate period of vocational adjustment under the superior's observation in order to enable competence to be demonstrated. Whether competence is up to date must also be reviewed at regular intervals.

For electrical work on HV systems, employees must be familiarized with theoretical electrical principles and equipped with the practical skills required for work with the relevant HV components, tools and auxiliary materials.



Figure 4:
Example of equipping with practical skills in work on HV systems

The necessary training of the employees must be performed by persons with the requisite knowledge in the area of instruction concerned, teaching ability, and experience in the training of adults. During training, suitable training materials must be provided and practical exercises performed. Successful completion of the training measure must be documented by the body providing the training in a verifiable manner with statement of the topics covered.

The employer/superior must ensure that only employees who are suitably qualified are tasked with work on HV systems (For a model certificate of attendance, see **Annex 10**).

Skills for work on HV systems

Persons who are to carry out electrical work on HV systems must be trained for this work. The scope of training depends in part upon the scale of the electrical hazards occurring during the work and upon the employee's prior knowledge.

Employees possessing the expertise (only) for work on HV systems may carry out electrical work only on components of the vehicles' systems. Such experts may not therefore perform work on conventional electrical systems and equipment, particularly external charging equipment and accessories for vehicles. This also applies to mounted and fixed equipment on the vehicles in accordance with the European Machinery Directive. When the experts are assigned to tasks, consideration must be given to whether they are trained for electrical work within the engineering and development process (prior to SoP), for fitting of the HV system, or for service work on series-production vehicles (post-SoP). The areas in which employees may carry out electrical work must be taken from the relevant certificates and evidence of training (Refer to **Annex 11** for a model certificate).

The relationship between the level of electrical hazard associated with the tasks in the relevant area of activity and the resulting scope of theoretical and practical training is illustrated by the following diagram.

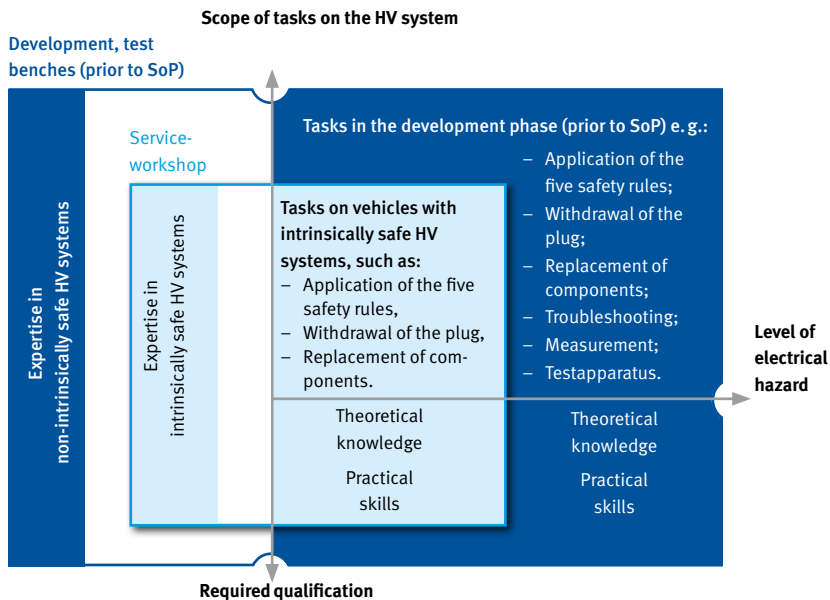

Diagram 1: Expertise in HV systems, presented by way of example with reference to the tasks to be performed

Employees with expertise in work on HV systems may perform electrical work on vehicles independently and with the technical responsibility for doing so.

Skilled electrical person

A skilled electrical person may **bear technical responsibility or carry out electrical work only in the discrete areas of electrical engineering** for which he or she has:

- Undergone specialist training,
- Acquired knowledge and experience,
- Become familiar with the relevant regulations.

By satisfying these requirements, the skilled electrical person is able to assess the work with which he or she is tasked in order to be able to recognize possible hazards and define the necessary protective measures.

The requirement for specialist training must generally be satisfied by completion of recognized skilled electrical training or other electrical qualification that is comparable with regard to the intended tasks.

The required knowledge and experience must be assured by recent vocational activity in the area of electrical engineering concerned.

“Knowledge of the relevant regulations“ refers in Germany in the first instance to those of VDE, statutory regulations and accident prevention regulations.

The term “skilled electrical person“ does not denote a particular vocation, but defines the ability, capacity and skill required for an employee to perform electrical work in a certain area of electrical engineering independently and on their own responsibility. A skilled electrical person always bears technical responsibility, i. e. is responsible for the technical result of the electrical work which he or she has performed. Should the skilled electrical person also be assigned the task of control and supervision of persons under his or her authority, he or she is responsible for guidance of these persons and for the technically correct and safe performance of the work.

Responsible skilled electrical person

The technical responsibility for an electrical business or part of a business must generally be held by a responsible skilled electrical person, who by definition has successfully completed training as a state-examined technician or master craftsman in trade or industry, or has a bachelor’s, master’s or other degree in engineering.

This is necessary when, in addition to the work on site associated with the electrical work, further tasks are required, such as:

- Planning, engineering, design,
- Organization of work,
- Definition of working procedures,
- Selection of suitable operatives and supervisory personnel,
- Communication and explanation of the relevant safety regulations,
- Specification of the tools and equipment to be used,
- Performance of necessary training measures,
- Monitoring of operations by random inspections or verification of success.

A responsible skilled electrical person must assume responsibility for supervision, in addition to the technical responsibility. This person must be appointed by the employer and must not be subject to power of direction regarding observance of the electrical safety measures. The electrical safety is the responsibility solely of the responsible skilled electrical person, and not of a superior holding solely disciplinary responsibility.

Service workshops in which work is performed on series production vehicles with intrinsically safe HV systems do not generally require a responsible skilled electrical person.

Person who has received electrical instruction

Persons who have (only) received electrical instruction may not carry out any work on electrical systems and equipment under their own responsibility. They may carry out work only with which they have been properly familiarized. During such work they must apply the measures and codes of behaviour in which they have been trained. All electrical work must be performed under the control and supervision of a skilled electrical person.

Control and supervision by a skilled electrical person means the assumption of man-management and technical responsibility, particularly for the following tasks:

- Provision of instruction to persons who have received electrical instruction,
- Monitoring of the proper erection, modification and maintenance of electrical systems and equipment,
- Arranging for, implementing and checking the safety measures required for the work to be performed, including the provision of safety facilities,
- Implementation of the safety measures required for the work to be performed; if necessary, the checking of the safety measures taken,
- Instruction of unskilled personnel in safe behaviour; if necessary, familiarization measures,
- Monitoring of work and of the personnel, for example during the performance of non-electrical work in the proximity of live parts; if necessary, supervision.

3. Risk assessment

Under the German occupational safety and health act, the employer is obliged to assure and if necessary improve the protection of employees' safety and health. An important step in this context is risk assessment.

Risk assessment is a process for identifying hazards and evaluating the associated risks. Evaluation of the hazards is a precondition for the taking of effective OSH measures relevant to the company.

Risk assessment consists of:

- Systematic identification and evaluation of relevant hazards,
- Definition of appropriate OSH measures.

One source of hazards are unsuitable qualifications of and instructions to the employees.

All OSH measures must comply with the general principles of hazard prevention set out in the German occupational safety and health act. The principle of hazard minimization must be applied. Owing to their higher vehicle electrical system voltages and electrical energy, HV systems present a hitherto unknown level of electrical hazard. A risk exists of irreversible injury following electric shock or arcing.

The spatial and temporal coincidence of the hazards and human beings must be prevented by suitable measures.



Figure 5:
Basic protection by isolation and shrouding

Measures are classified as follows:

- Technical, e.g. isolation, fixed shrouding,
- Organizational, e.g. the observance of specified waiting times to allow for the dissipation of voltage,
- Personal, e.g. personal protective equipment (insulating gloves, helmet with visor), instruction.

A combination of these measures is also possible. Technical measures are to be given priority over organizational or personal measures.

The protective measures implemented in the vehicles differ from one manufacturer to another. The protective measures are such that no single fault alone is able to present an electrical hazard to persons. A selection of protective measures which have been implemented in various vehicles are listed below:

- Disconnection of the entire HV system by means of an isolating facility (such as service disconnect, maintenance plug),
- Plug-and-socket arrangement for all cable connections,
- Components and plug-and-socket connections to at least IP 2X in the disconnected state, to at least IP 4X in the connected state, to EN 60529 (VDE 0470-1),

- Safety loop (interlock) for all HV components; plug-and-socket connections with at least single-fault tolerance,
- Shrouds of parts that are live and not protected against direct contact can be removed only by means of tools or by destruction,
- Disconnection of the system voltage by means of early-breaking plug contacts when plug-and-socket connections are broken, for the prevention of fault arcs,
- Disconnection of electrical circuits when covers are opened, possibly including the engine cover,
- Mechanical arrangements for the removal of components/opening of covers and shrouds requiring a time greater than the discharge time for the residual voltages,
- Permanent, built-in facility for determining the non-live state of the HV system,
- Uniform, clearly identifiable marking of all HV components, for example by orange conductors,
- Creation of an electrical system which is not earthed and which is isolated against the vehicle earth and the individual conductors,
- Monitoring of insulation of the live conductors against vehicle earth,
- Deliberate discharge of residual energy from the energy storage components, such as capacitors,
- Connection of all exposed conductive vehicle parts by potential equalization in order to prevent the formation of different potentials.

A model risk assessment for an automotive workshop can be found in **Annex 1**.

Where suitably combined, technical measures alone are sufficient to ensure complete protection against electric shock and arcing from the HV system. The vehicle can then be described as having an “intrinsically safe HV system”.



Figure 6: Marking of HV vehicles in the workshop

IV. Training for work in development and manufacture

1. Qualification stages for work to be performed prior to the start of production

1.1 General

Training (topics and duration) is classified in three stages in consideration of the hazard and the work to be performed. The topics of training listed serve only as an example and must be adapted to the specific requirements of the tasks. Training must be concluded by theoretical and practical examination demonstrating the skills and knowledge acquired. The demonstration of this acquisition must be documented.

The following staged model shows the required qualification as a function of the work to be performed:

		Stage 3	For example
		Live work on the HV system and work in the proximity of exposed live parts	<ul style="list-style-type: none"> – Troubleshooting, – Replacing parts live.
	Stage 2	For example	
	<ul style="list-style-type: none"> – Disconnection – Electrical work in the non-live state 	<ul style="list-style-type: none"> – Isolation, – Safeguarding against reconnection, – Verification of the non-live state, – Replacement of HV components, – Withdrawal of the plug + replacement of components (e. g. DC/DC converter, electric air-conditioning). 	
Stage 1	For example		
Non-electrical work	<ul style="list-style-type: none"> – Test driver, – Bodywork repairs, – Oil change, wheel change. 		

Stage 1 describes all non-electrical work which is required on a vehicle or installations containing HV systems. The employees must be informed of the possible electrical hazards presented by the HV system and of the intended use of the vehicle.

Stage 2 requires expertise in work on HV systems which are not intrinsically safe. This includes all electrical work performed in the non-live state. This requires de-commissioning and recommissioning of the HV system in accordance with application and performance of the first three of the “five safety rules“.

A precondition for training to **Stage 3** is successful completion of training to Stage 2 and safe performance of the associated practical tasks. Training for live work on the HV system qualifies the employee for all electrical work on the vehicle.

If it is found during the production development process that components are fitted which satisfy the safety standards of series production, they can be assigned to a post-SoP training stage. The corresponding decision must be taken by the responsible skilled electrical person.

The flow charts in **Annex 2** and **Annex 3** provide support in determining the requisite scope of training.

The scope of training stated includes the teaching of theoretical knowledge and practical skills.

1.2 Qualification for Stage 1: non-electrical work

		<p>Stage 3</p> <p>Live work on the HV system and work in the proximity of exposed live parts</p>	<p>For example</p> <ul style="list-style-type: none"> - Troubleshooting, - Replacing parts live.
	<p>Stage 2</p> <ul style="list-style-type: none"> - Disconnection - Electrical work in the non-live state 	<p>For example</p> <ul style="list-style-type: none"> - Isolation, - Safeguarding against reconnection, - Verification of the non-live state, - Replacement of HV components, - Withdrawal of the plug + replacement of components (e.g. DC/DC converter, electric air-conditioning). 	
<p>Stage 1</p> <p>Non-electrical work</p>	<p>For example</p> <ul style="list-style-type: none"> - Test driver, - Bodywork repairs, - Oil change, wheel change. 		

Instruction is required for all non-electrical work to be performed on the HV vehicle.

This instruction is intended to raise the employees' awareness of the HV systems in order to enable them to work safely on the vehicle. The objective is for employees to be able to operate the HV components safely, to understand their structure and principles of operation, and to be familiar with the markings of the components. The topics covered by instruction must also cover the fact that electrical work on HV components is not permissible. Failure to observe these requirements may lead to dangerous electric shock or arcing.

The topics of this instruction must include:

- Operation of vehicles and the associated equipment (e. g. test rigs),
- Performance of general tasks which do not require isolation of the HV system,
- Performance of all mechanical tasks on the vehicle (but: don't touch orange!),
- Isolation of the HV system, additional safety measure in the form of withdrawal and plugging in of the service disconnect/maintenance plug,
- Appointment of the individual to be consulted in the event of uncertainty,
- Impermissible work on the vehicle,
- Organizational procedure for electrical work that is performed under the control and supervision of a skilled electrical person for HV systems.

Instruction in Stage 1 must last between 2 and 4 teaching periods.

1.3 Qualification for Stage 2: electrical work

<p>Stage 3</p> <p>Live work on the HV system and work in the proximity of exposed live parts</p>	<p>For example</p> <ul style="list-style-type: none"> – Troubleshooting, – Replacing parts live.
<p>Stage 2</p> <ul style="list-style-type: none"> – Disconnection – Electrical work in the non-live state 	<p>For example</p> <ul style="list-style-type: none"> – Isolation, – Safeguarding against reconnection, – Verification of the non-live state, – Replacement of HV components, – Withdrawal of the plug + replacement of components (e. g. DC/DC converter, electric air-conditioning).
<p>Stage 1</p> <p>Non-electrical work</p>	<p>For example</p> <ul style="list-style-type: none"> – Test driver, – Bodywork repairs, – Oil change, wheel change.

Employees must have an electrical qualification for any Stage 2 electrical work to be performed on the HV vehicle.

Training for Stage 2 must take account of the particular electrical knowledge already acquired by the employee.

Stage 2a: persons without prior electrical knowledge but with technical training

Topics covered by training:

- Basic electrical knowledge,
- Electrical hazards and first aid,
- Measures for protection against electric shock and against fault arcs,
- Organization of safety and health for electrical work,
- Specialist and man-management responsibility,
- Employee qualifications in the area of electrical engineering,
- Use of HV systems in the vehicle.

A specification of the topics covered by training can be found in **Annex 4**.

The training must encompass at least 100 teaching periods.

Stage 2b: persons with prior electrical knowledge in the automotive sector, e. g. auto-electricians, automotive mechatronics technicians, car mechanics

Topics covered by training:

- Electrical hazards and first aid,
- Measures for protection against electric shock and against fault arcs,
- Organization of safety and health for electrical work,
- Specialist and man-management responsibility,
- Employee qualifications in the area of electrical engineering,
- Use of HV systems in the vehicle.

A specification of the topics covered by training can be found in **Annex 5**.

The training must encompass at least 48 teaching periods.

Stage 2c: skilled electrical persons, e.g. industrial electronics specialists, electrical fitters, electrical engineers

Topics covered by training:

- Specialist and man-management responsibility,
- Employee qualifications in the area of electrical engineering,
- Use of HV systems in the vehicle,
- Design and function of vehicle electrical systems.

A specification of the topics covered by training can be found in **Annex 6**. The topics must be adapted to the participants' current level of knowledge.

The training must encompass at least 20 teaching periods.

1.4 **Qualification for Stage 3: live electrical work**

Successful completion of training to Stage 2 is a prerequisite. Training for live working on HV systems requires sound knowledge of electrical theory and usable practical electrical skills; proof of adequate health, particularly in the form of an occupational medical examination in accordance with DGUV Principle G 25 governing driving, control and monitoring tasks; a minimum age of 18 years; and training in first aid (including cardiopulmonary resuscitation).

<p>Stage 3</p> <p>Live work on the HV system and work in the proximity of exposed live parts</p>	<p>For example</p> <ul style="list-style-type: none"> - Troubleshooting, - Replacing parts live.
<p>Stage 2</p> <ul style="list-style-type: none"> - Disconnection - Electrical work in the non-live state 	<p>For example</p> <ul style="list-style-type: none"> - Isolation, - Safeguarding against reconnection, - Verification of the non-live state, - Replacement of HV components, - Withdrawal of the plug + replacement of components (e.g. DC/DC converter, electric air-conditioning).
<p>Stage 1</p> <p>Non-electrical work</p>	<p>For example</p> <ul style="list-style-type: none"> - Test driver, - Bodywork repairs, - Oil change, wheel change.

Stage 3a: employees who are qualified to Stages 2b and Stage 2c

Employees who are qualified to Stages 2b and 2c already satisfy the conditions for training to Stage 3.

These employees require additional training for live work on HV systems.

Topics covered by training:

- Definition of the scope,
- Conditions for live work on HV systems:
 - Competence of the employees,
 - Organization of the work,
 - Protective and other equipment to be used,
- Practical exercises.

The training must encompass at least 8 teaching periods.

Stage 3b: employees who are qualified to Stage 2a

Employees qualified to Stage 2a do not necessarily possess the sound theoretical and practical electrical knowledge and skills required for live work on HV systems. The employees' existing knowledge must therefore be reviewed in order for the additional knowledge and skills required as conditions for training to Stage 3 to be determined.

(1) Prior training: engineering or scientific study

Employees who for example have completed an engineering or scientific degree possess theoretical electrical knowledge by which they can evaluate the work to Stage 3. Such employees must be equipped with practical skills as a condition for live work on HV systems.

Equipping with practical skills may focus upon the following aspects:

- Electrical instrumentation,
- Performance of measurements in accordance with the electrical standards (e. g. VDE provisions),
- Circuit engineering,
- Use of tools in electrical fitting work,

- Laying and securing of wiring,
- Creation and wiring of circuits according to circuit documentation (parts list, terminal assignment plan, assembly plan and circuit diagram),
- Sensor technology in control engineering,
- Connection and operation of peripheral equipment,
- Function testing on digital switching devices and circuits,
- Fault analysis, systematic troubleshooting, use of vehicle or system diagnostics equipment,
- Elimination of faults.

These employees also require training in live work on the HV system in accordance with Stage 3a.

Topics covered by training:

- Definition of the scope,
- Conditions for live work on HV systems:
 - Competence of the employees,
 - Organization of the work,
 - Protective and other equipment to be used,
- Practical exercises.

The training must encompass at least 48 teaching periods.

(2) Prior training: non-electrical training or apprenticeship in a skilled trade

Employees who have (only) completed training or an apprenticeship in a non-electrical skilled trade possess neither the necessary basic electrical knowledge nor the practical skills by means of which they can evaluate the work to Stage 3. Such employees require further theoretical and practical training as a condition for the performance of live work on HV systems.

Equipping with theoretical and practical skills may focus upon the following aspects:

- Electrical instrumentation,
- Performance of measurements,
- Circuit engineering,
- Use of tools in electrical fitting work,
- Laying and securing of wiring,
- Creation and wiring of circuits according to circuit documentation (parts list, terminal assignment plan, assembly plan and circuit diagram),
- Sensor technology in control engineering,
- Connection and operation of peripheral equipment,
- Function testing on digital switching devices and circuits,
- Fault analysis, systematic troubleshooting, use of vehicle or system diagnostics equipment,
- Elimination of faults.

These employees also require training in live work on the HV system in accordance with Stage 3a.

Topics covered by training:

- Definition of the scope,
- Conditions for live work on HV systems:
 - Competence of the employees,
 - Organization of the work,
 - Protective and other equipment to be used,
- Practical exercises.

The training must encompass at least 100 teaching periods.

2. Training for work relating to production and commissioning during the manufacturing process

2.1 Assembly

Production of an HV system necessitates electrical work. Control and supervision of this electrical work within the assembly process can be exercised by the responsible man-management personnel based upon standardized working procedures. This necessitates the formulation of binding work instructions which contain the procedure to be followed during this work, including the hazards which arise and the associated protective measures to be taken. Review of the standardized work instructions for their technical correctness is the task of a skilled electrical person, who owing to his or her sound knowledge and skills is qualified for this task.

The topics covered by the work instructions must be communicated to the employees by familiarization (for example in the course of product training) or instruction. The employees must understand the material.

The relevant superiors are responsible for sustained integration of the standardized work procedures into the production process, generation of the requisite documentation, and monitoring of implementation.

2.2 Commissioning following assembly

Once the HV system has been commissioned by connection to the power source, the hazard potential increases. Depending upon the task to be performed on the vehicle, this may necessitate further training measures for the employees. The following distinctions in particular, which take account of differences in hazard potential, must be drawn in this context:

a) Commissioning of batteries with full protection against accidental contact and arcing

Commissioning is adequate if performed in accordance with standardized work procedures (as described for assembly) by a person who has received electrical instruction.

b) Commissioning of batteries without full protection against accidental contact and arcing

Protection against electric shock and fault arcs is not assured by technical means alone. Such work may be performed only by employees qualified to Stage 2 in accordance with the stage model.

c) Reworking without faults in the HV

Should reworking not require intervention in the HV system, this work may be performed in accordance with standardized work procedures by a person who has received electrical instruction, as described for production-line assembly. This includes work on the conventional vehicle electrical system up to 30 V AC and 60 V DC.

d) Reworking with faults in the HV

Should electrical work be required on the HV system, its non-live state must be assured. This work requires an employee qualified to Stage 2 in accordance with the stage model. These provisions also include work on the conventional vehicle electrical system up to 30 V AC and 60 V DC if components of the HV system are affected.

Live work may be necessary for troubleshooting on the HV system. In this case, qualification to Stage 3 in accordance with the stage model is required.

2.3 Electrical tests

Where electrical tests are performed in the manufacturing/assembly process, for example tests of the continuity of the potential equalization, insulation tests, voltage tests, etc., the following distinctions must be drawn regarding the required qualification:

- If the intrinsic safety of the HV system is not assured, employees qualified to Stage 3 must be tasked.
- Where testing is performed with full protection against electric shock and fault arcing, qualification to Stage 2 is required if the measurement result is to be evaluated. If evaluation of the measurement result is not required, qualification to Stage 1 is sufficient.

The provisions of DIN EN 50191 (VDE 0104) and of the BGI 891 informative document (in german) must be observed.

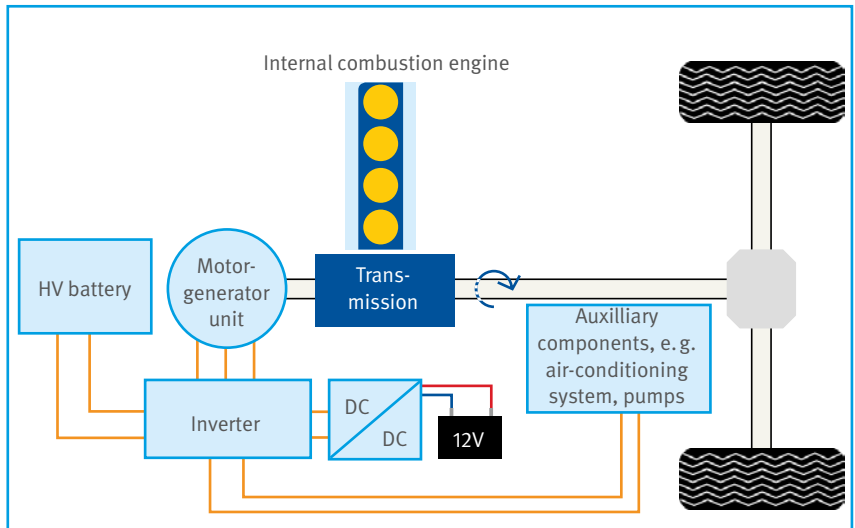

Diagram 2: Model block diagramm of a prallel hybrid drive

V.

Training for work on series production vehicles

The following tasks arise on HV vehicles in the service workshops:

- Operation of the vehicles,
- Non-electrical work (e. g. panel work, oil changes, wheel changes),
- This includes work on the electrical components of the conventional vehicle electrical system up to 30 V AC/60 V DC,
- Electrical work on the HV system.

Owing to the high value of commercial, more substantial damage to them that would generally lead to a passenger car being scrapped is also repaired in the service workshops.

1. Operation of vehicles

The employees must be made familiar with the vehicle-specific properties of HV vehicles and with their intended use. For the operation of HV vehicles, it is sufficient for employees to be made familiar with the particular aspects to be observed. This also applies to service work, which is comparable to operation in terms of the electrical hazard. Examples of such work are:

- Replacement of windscreen wiper blades,
- Refilling of screenwash,
- Special procedures for retrospective equipping of the vehicle,
- Everyday preparation for use,
- Use of familiar filling points in unusual locations,
- Use of controls bearing new symbols and hazard markings.

The scale of familiarization is geared to the scale of the features particular to the vehicle and to the tasks to be completed.

These employees may not carry out any work on the HV system or in the proximity of HV components if a risk exists of the latter being damaged.

2. Non-electrical work

In addition to the intended use of the vehicle, non-electrical work must also be performed on it (e.g. panel work, oil and wheel changes, brake component replacement in the proximity of wheel hub motors, work on dampers in the proximity of the HV lines) and electrical work on the conventional vehicle electrical system (up to 30 V AC and 60 V DC). Employees may be exposed to an electrical hazard during this work owing to human error or faults. They must be made familiar with these hazards, the protective measures and the codes for behaviour. The topics and duration of instruction must be geared to the nature of the work to be conducted and to the anticipated hazard potential associated with it.

More comprehensive mechanical work which may be performed in the proximity of HV components, such as welding, drilling or grinding work, requires knowledge of the precise location of the HV components. Employees' awareness must be raised of the hazards which may arise during the use of tools and other equipment in the proximity of the HV system. They must be familiar with the markings of the components. The instruction must include making them aware that work on the HV components is not permissible. Inadvertent kinking or crushing of HV lines or damage to them must be reported to the responsible expert. Failure to observe these requirements may lead to dangerous electric shock or arcing.

The instruction must be documented.

The topics of this instruction must include:

- Operation of vehicles and the associated equipment,
- Performance of general tasks which do not require isolation of the HV system,
- Location and marking of the HV components and lines in and on the vehicle,
- Performance of all mechanical tasks on the vehicle (but: don't touch orange!),
- Isolation of the HV system as specified by the manufacturer, serving as an additional safety measure to prevent unauthorized or inadvertent use,
- Appointment of the individual to be consulted in the event of uncertainty (such as the expert in HV systems),
- Impermissible work on the vehicle,

- Organizational procedure for electrical work that is performed under the control and supervision of a skilled electrical person for HV systems.

Instruction must last for between 0,5 and 2 teaching periods, according to the nature and scale of the work.

3. Electrical work

Work on the conventional vehicle electrical system up to 30 V AC/60 V DC must be distinguished from the work on HV components. The scope of training depends in part upon the level of the electrical hazard (implementation of intrinsic HV safety on the vehicle) and upon the employee's prior knowledge.

In the skilled vocations in the automotive sector, basic electrical knowledge is taught in the theoretical component and work involving the conventional vehicle electrical system up to 30 V AC/60 V DC in the practical component, according to the relevant curricula. In addition, the measurement of electrical values and work on electrical components and systems is taught in a practical way in both industry-wide and company-level training. This has been the case in Germany for trades including those of car mechanic, auto-electrician and automotive mechatronic technician since 1973, and for those of car-body repairer, body and vehicle construction mechanic since 2002. Persons who have successfully qualified in one of these skilled vocations since the dates stated or have completed a comparable vocational course of training, for example a degree in automotive engineering, or who are able to demonstrate appropriate further specialist training as an automotive service technician or master car mechanic, already possess the necessary basic electrical knowledge. Based upon this level of knowledge and experience, these employees receive further training in work on vehicles with HV systems. Persons without prior electrical knowledge must in addition be taught basic electrical principles.

In order for the prospective participant's current level of knowledge and experience to be quantified prior to the training measure, the necessary electrical knowledge must be determined by a pilot test. This provides both the participant and the employer with the certainty that the prior knowledge is sufficient for successful completion of the training measure.

The theoretical and practical training must be concluded with demonstration of the skills and knowledge that have been acquired. The demonstration of the acquired skills and knowledge must be documented.

3.1 **Service workshops for vehicles with intrinsically safe HV systems, particularly passenger cars**

The training described below assumes that work is being performed on vehicles with intrinsically safe HV systems. Should the intrinsically safe nature of the HV system not be assured, training as described in Chapter 3.2 for service work on commercial vehicles is required.

The flow chart in **Annex 7** provides support in determining the necessary scope of training.

The topics covered by training listed serve as an example only and must be adapted to the specific requirements of the tasks.

a) Prior training: persons without prior electrical knowledge but with technical training

Topics covered by training:

- Basic electrical knowledge,
- Electrical hazards and first aid,
- Measures for protection against electric shock and against fault arcs,
- Organization of safety and health for electrical work,
- Specialist and man-management responsibility,
- Employee qualifications in the area of electrical engineering,
- Use of HV systems in vehicles.

A specification of the topics covered by training can be found in **Annex 4**.

The theoretical component of the training must encompass at least 72 teaching periods.

b) Prior training: persons with prior electrical knowledge in the automotive sector (e. g. auto-electricians, automotive mechatronics technicians, car mechanics)

Topics covered by theoretical training component:

- Specialist and man-management responsibility,
- Electrical hazards and first aid,
- Measures for protection against electric shock and against fault arcs,
- Electrical work in accordance with the BGV/GUV-V A3 accident prevention regulation and with DIN VDE 0105-100,
- HV concept and automotive technology, safety requirements in accordance with Federal ECE Rule 100.

A specification of the topics covered by training can be found in **Annex 8**.

The theoretical training component must encompass at least 8 teaching periods, plus examination.

c) Skilled electrical persons, e. g. industrial electronics specialists, electrical fitters, electrical engineers

Skilled electrical persons such as industrial electronics experts or electrical fitters possess the necessary basic electrical knowledge and require additional practical knowledge of work with high-voltage components.

Required additional practical component

Following the theoretical training, additional practical training components are required, according to the nature and scale of the HV system concerned (e. g. hybrid drive, fuel cell, electric vehicle). The actual scope must be based upon the manufacturer's specifications. The practical knowledge can be communicated by a number of different teaching methods in consideration of the work to be carried out on the

HV system. The practical component can also be carried out by the bodies responsible for the theory component, provided the relevant HV systems or comparable systems are available for performance of the practical tasks.

The theoretical knowledge acquired must be applied in the practical.

A duration of 4 to 8 teaching periods is required for the hybrid technology currently on the market.

The employer is responsible for assuring performance of the practical component.

Successful completion of training equips the employees to work independently and safely on vehicles with intrinsically safe HV systems. This work includes application of the five safety rules, replacement of HV components such as air-conditioning components and oil pumps in the non-live state, and troubleshooting on shock-proof HV components. The employees must be capable of evaluating the work, identifying possible hazards, and selecting and taking the protective measures required for the HV system.

3.2 Service workshops for vehicles without intrinsically safe HV systems, particularly commercial vehicles

Batteries, EDLCs (electrochemical double layer capacitors) and fuel cells with voltages of up to 1000 V DC are used as electrical energy storage devices in commercial vehicles (and elsewhere). The HV systems of commercial vehicles are not generally entirely intrinsically safe. (Where the intrinsic safety of the HV system is assured, training as described in Chapter 3.1 for service work on passenger cars is sufficient). Successful completion of training equips the employees to work independently and safely on vehicles with non-intrinsically safe HV systems. This work includes application of the five safety rules and replacement of HV components such as drive motors and energy storage devices in the non-live state. It also includes troubleshooting on HV components which may not necessarily be shockproof by means of shockproof test adapters. The employees thus qualified must be able to evaluate the work with which they are tasked, recognize possible hazards, and implement the protective measures necessary for the HV system.

The flow chart in **Annex 9** provides support in determining the necessary scope of training.

The topics covered by training listed serve as an example only and must be adapted to the specific requirements of the tasks.

a) Prior training: persons without prior electrical knowledge but with technical training

Topics covered by theoretical training component:

- Basic electrical knowledge,
- Electrical hazards and first aid,
- Measures for protection against electric shock and against fault arcs,
- Organization of safety and health for electrical work,
- Specialist and man-management responsibility,
- Employee qualifications in the area of electrical engineering,
- Use of HV systems in vehicles.

The topics covered by training must be specified with reference to **Annex 4**.

The theoretical component of the training must encompass at least 84 teaching periods.

Scope of the practical training component

Besides the theory, the practical component is important, particularly during the introduction of new technology and working procedures. For example, a comprehensive practical component must be included in further training for employees when vehicles with hybrid drive are used for the first time. Should the employees already satisfy the electrical qualification for comparable technology, e. g. EDLCs and batteries, it is sufficient for them to be made familiar in a practical manner with the technical differences and their influence upon the working procedures. The actual scope of the training should be defined in consultation with the vehicle manufacturer. The practical component can also be carried out by the bodies responsible for the theory component, provided the relevant HV systems or com-

parable systems are available for performance of the practical tasks.

The theoretical knowledge acquired must be applied in the practical.

Owing to the diversity of high-voltage technology and of its implementation by different manufacturers, the training should comprise 12 to 16 teaching periods.

Should the participants already be qualified as defined in Chapter 3.1 a), the existing qualification must be supplemented by the teaching in particular of subjects such as the absence of protection against electric shock and fault arcs, protective measures, tests and measurements. The supplementary training must encompass at least 10 to 12 teaching periods for the theory component and 8 to 12 teaching periods for the practical component.

b) Prior training: persons with prior electrical knowledge in the automotive sector (e.g. auto-electricians, automotive mechatronics technicians, car mechanics)

Topics covered by theoretical training component:

- Specialist and man-management responsibility,
- Electrical hazards and first aid,
- Measures for protection against electric shock and against fault arcs,
- Electrical work in accordance with the BGV/GUV-V A3 accident prevention regulation and with DIN VDE 0105-100,
- HV concept and automotive technology, safety requirements in accordance with Federal ECE Rule 100.

The topics covered by training must be specified with reference to **Annex 5**.

The theoretical training component must encompass at least 24 teaching periods and be geared in its duration to the degree of intrinsic safety of the HV system.

Scope of the practical training component

Besides the theory, the practical component is important, particularly during the introduction of new technology and working procedures. For example, a comprehensive practical component must be included in further training for employees when vehicles with hybrid drive are used for the first time. Should the employees already satisfy the electrical qualification for comparable technology, e. g. EDLCs and batteries, it is sufficient for them to be made familiar in a practical manner with the technical differences and their influence upon the working procedures. The actual scope of the training should be defined in consultation with the vehicle manufacturer. The practical component can also be carried out by the bodies responsible for the theory component, provided the relevant HV systems or comparable systems are available for performance of the practical tasks.

The theoretical knowledge acquired must be applied in the practical component.

Owing to the diversity of high-voltage technology and of its implementation by different manufacturers, the training should comprise 12 to 16 teaching periods.

Should the participants already be qualified as defined in Chapter 3.1 b), the existing qualification must be supplemented by the teaching in particular of subjects such as the absence of protection against electric shock and fault arcs, protective measures, tests and measurements. The supplementary training must encompass at least 10 to 12 teaching periods for the theory component and 8 to 12 teaching periods for the practical component.

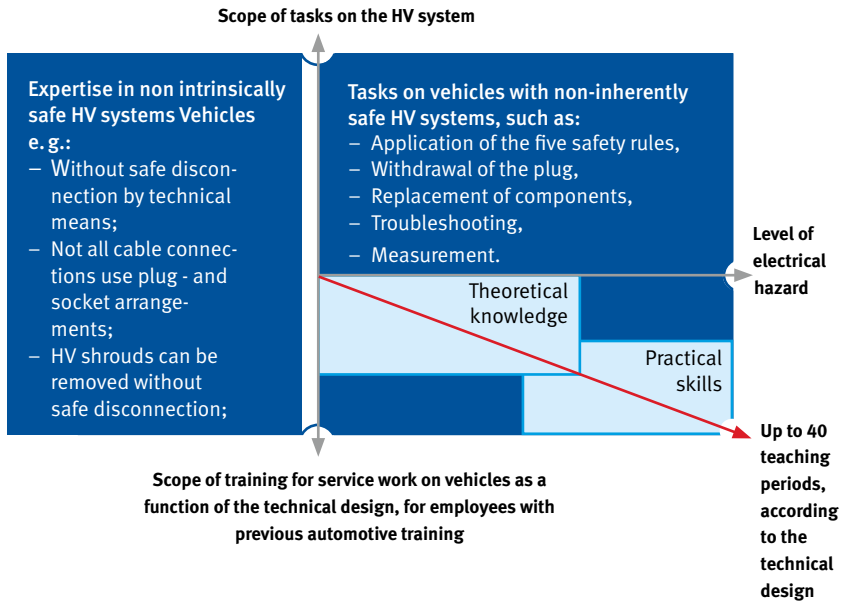

Diagram 3: Training diagram - vehicles with non-intrinsically

c) Skilled electrical persons, e. g. industrial electronics specialists, electrical fitters, electrical engineers

Skilled electrical persons possess the necessary basic electrical knowledge. They also possess practical knowledge of work with the high-voltage components.

Owing to the diversity of high-voltage technology and of its implementation by different manufacturers, the training should comprise 12 to 16 teaching.

Should the participants already be qualified as defined in Chapter 3.1 c), supplementary practical training lasting for 8 to 12 teaching periods is required which particularly addresses the hazards presented by non-inherently safe HV systems.

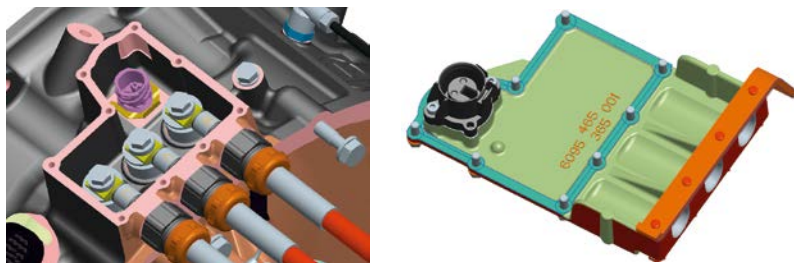

Figure 7: Example of safe disconnection by technical means for the removal of shrouds by means of pilot contact

3.3 Work on live energy storage devices and at test stations

Work on vehicles with HV components must as a rule be performed in the non-live state with observance of the five safety rules. Should work be required in which live parts may not necessarily be safeguarded against contact, for example during troubleshooting or work on energy storage devices or at electrical test stations, the employees must receive additional training. A condition in all cases is training of those concerned as described in Chapter 3.2 for work on vehicles with non-intrinsically safe HV systems; demonstration of satisfactory health, particularly in the form of an occupational medical examination in accordance with DGUV Principle G 25 governing driving, control and monitoring tasks; a minimum age of 18 years; and training in first aid (including cardiopulmonary resuscitation).

Work on the live parts of energy storage devices is required for example when the design of these devices prevents them from being replaced complete and necessitates repair in situ.

The manufacturer's provisions and the requirements of DIN EN 50191 (VDE 0104) and of the BGI 891 informative document concerning test stations must be observed during the testing of HV components. The employees must have experience in working with the components to be tested.

Essential topics covered by training:

- Safe working procedures,
- Competence of the employees,
- Organization of the work,
- Tools and protective, testing and other equipment to be used,
- Safeguarding of the working areas,
- Marking of vehicles on which live parts are exposed,
- Test equipment,
- Specific non-electrical hazards, such as chemical hazards, risk of fire and explosion,
- Practical exercises.

The training of experts in accordance with 3.2 b) and 3.2 c) must last at least 8 teaching periods. Depending upon the complexity of the technology used and the work to be carried out, additional practical tuition may be required, for example an additional 4 teaching periods for cell changing on HV batteries.

Owing to the differences between suitable existing qualifications, the scope of training for experts to Chapter 3.2 a) must be determined on a case-by-case basis with reference to Section IV Chapter 1.4.



Figure 8:
Example of safeguarding of the working area during testing work

4. Accident assistance

Where vehicles have suffered light damage in an accident, the accident recovery services repair it on site in order to make the vehicles drivable immediately if at all possible. More major damage is always repaired in the workshop.

Where vehicles have been damaged so severely that flammable liquids leak, the accident recovery service has the task of safeguarding the danger zone.

The HV components are fitted within the vehicle in such a way as to protect them against damage in the event of an accident. Despite this, parts of a damaged vehicle could be live following an accident. The safety of the emergency service personnel in such cases must be assured. For this purpose the emergency services must isolate the vehicle's electrical system and safeguard any exposed live parts. Guides providing corresponding information on particular vehicles are available for emergency service personnel.

The topics covered by the training stated below assume that repairs to the HV system are not being performed outside the workshop.

Topics covered by training:

- Location of the HV components and lines in series production vehicles,
- Operation of vehicles and the associated equipment,
- Performance of general tasks which do not require isolation of the HV system,
- Performance of all mechanical tasks on the vehicle (but: don't touch orange!),
- Electrical isolation of the vehicle as an additional safety measure,
- Appointment of the individual to be consulted in the event of uncertainty,
- Impermissible work on the vehicle.

The instruction must encompass at least 2 teaching periods.

5. Scrappage

Consideration must be given to the electrical hazards presented by the HV vehicle when it is scrapped. HV vehicles are not always identifiable externally as such. For this reason, vehicles must be examined prior to scrappage for the possible presence of HV components. The orange cables, the decals indicating high voltage and batteries marked with higher voltages than the conventional 12, 24 and 42 V are clear indications that the vehicle has an HV system. Under normal circumstances, the HV components fitted to series production vehicles with intrinsically safe HV systems do not present an electrical hazard. Should the cable insulation or the shrouding of the HV components be damaged or destroyed however, a risk exists of arcing caused by short-circuits or of electric shock in the event of contact with the live parts.

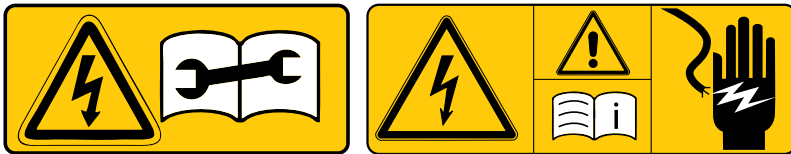

Figure 9: Example of the marking of HV components

Prior to scrappage, the HV system must be isolated and the HV components disconnected from the vehicle electrical system and prepared for removal. These tasks must be performed by an employee competent to perform work on vehicle HV systems and with application of the five safety rules and observance of the manufacturer's instructions for the specific vehicle. The electrical energy storage devices (such as batteries and EDLCs) must then be removed in accordance with the manufacturer's instructions and properly disposed of.

Annex 1 Model risk assessment

Muster-Arbeitsblatt zur Ermittlung der Gefährdungen und Maßnahmen

<input type="checkbox"/>	Working area: automotive workshop
<input type="checkbox"/>	Vocational group/person
<input type="checkbox"/>	Task Work on vehicles with intrinsically safe HV systems

Informative publication	Hazards identified and description of them	Evaluate hazards			Measures	Author/ advisor	Date		Effective	
		Risk		Need for action yes/no			Completed	Yes	No	
		L	M	H						
.....	<input type="checkbox"/> Electric shock <input type="checkbox"/> Arcing				<input type="checkbox"/> Familiarization/instruction of all employees with/on hazards and work on HV vehicles. <input type="checkbox"/> During non-electrical work on the vehicle, checking of whether HV components are fitted in the working area. <input type="checkbox"/> Visual inspection of the HV components for externally visible defects. <input type="checkbox"/> Training of employees in the expertise required for work on the HV system. <input type="checkbox"/> Work on the HV system may be carried out only by employees who possess the necessary expertise, or under the control and supervision of such employees. <input type="checkbox"/> Performance of work on the HV system following application of the five safety rules <ul style="list-style-type: none"> - Isolate HV voltage, - Safeguard against reconnection, - Verify the non-live state. <input type="checkbox"/> Use of suitable voltage testers or test equipment. <input type="checkbox"/> Performance of work on the HV system only in accordance with the manufacturer's instructions and with use of the specified tools and other equipment. <input type="checkbox"/> Marking of vehicles and safeguarding of the working area during electrical work.	<input type="checkbox"/>	<input type="checkbox"/>
.....					<input type="checkbox"/>	<input type="checkbox"/>



Annex 2

Flow chart: need for training for work during development, on test rigs (isolated)

Identification of need for training for non-live work prior to SoP

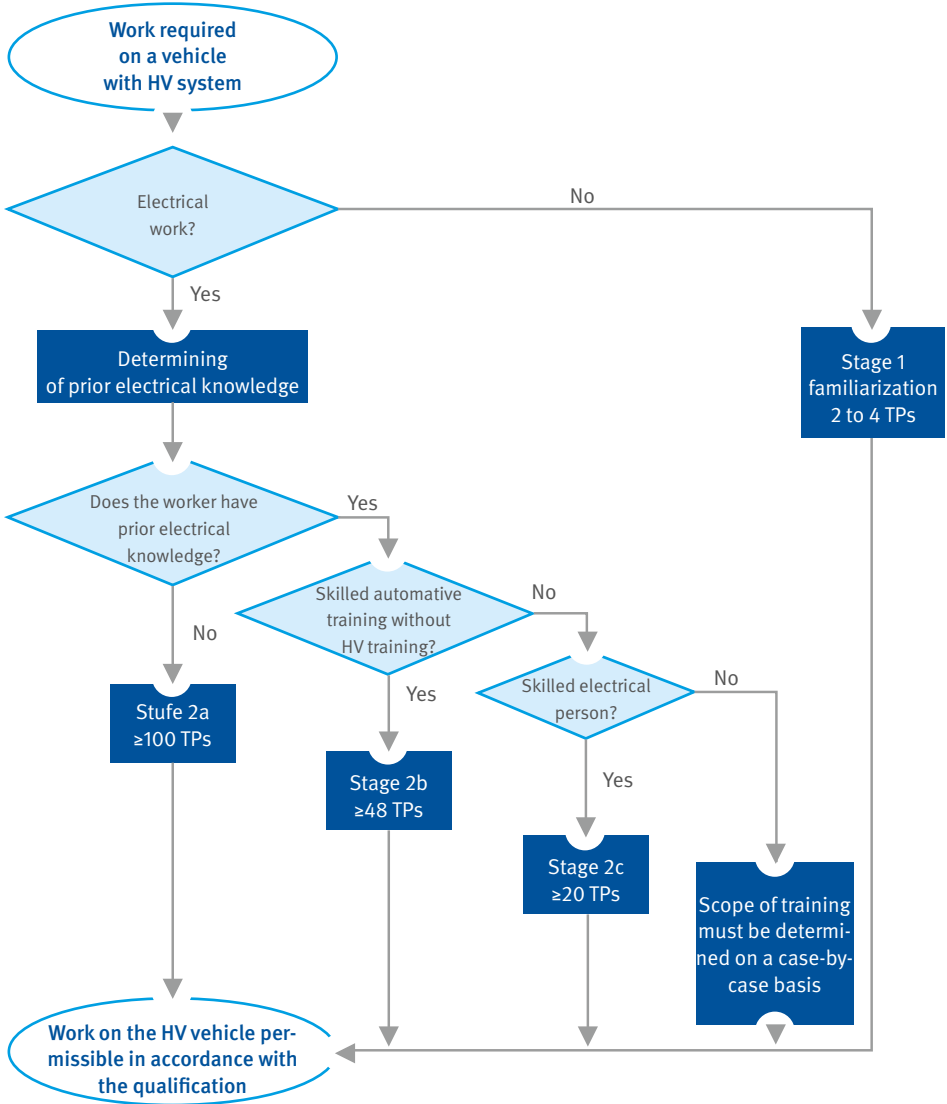

Annex 3

Flow chart: need for training for work in development, on test rigs (live)

Determining of the need for training for live work

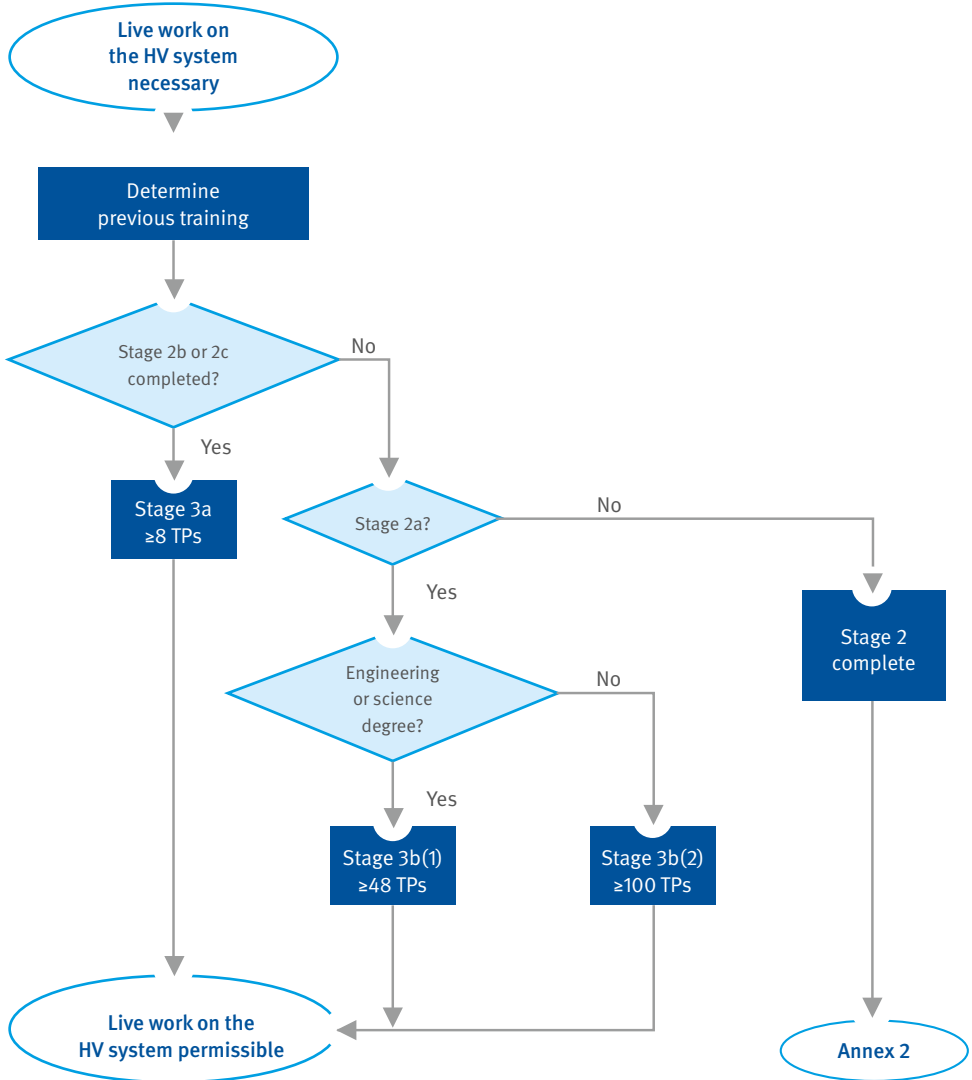

Annex 4

Topics covered by training for persons without prior electrical knowledge but with technical training

The topics indicated below serve as an example only and reflect the current state of the art of automotive HV technology. Topics irrelevant to the work to be carried out can be ignored. Other relevant topics must be added in their place if necessary.

Basic electrical knowledge

- Electric voltage,
- Electric current,
- Direct current, alternating current, three-phase current,
- Calculations involving powers of ten,
- Power sources,
- Electrical resistance:
 - Ohm's Law,
 - Connection in series,
 - Connection in parallel.
- Electric power,
- Forms of power generation,
- Power sources:
 - Fuel cell, EDLCs, batteries (lithium-ion, nickel-metal hydride),
 - Charging regulations.
- Coil,
- Electric motor,
- Three-phase asynchronous motor,
- Three-phase generator,
- Transformer,
- Semiconductors, diodes, bipolar transistors,
- Design of a relay,
- Design of a capacitor,
- Use of a capacitor to smooth undulating voltage,

- Instruments and measurement methods:
 - Analogue and digital instruments,
 - Measurement of current, voltage and resistance,
 - Measurement errors,
 - Troubleshooting on vehicles,
 - Diagnostics.
- Reading off and use of measurement results is practised in order for measurement displays to be read and interpreted correctly.
- Measurement of V/R/I, use of voltmeters, ammeters and electronic boards.
- Production/interpretation of V/I diagrams in preparation for the specialist module.
- Estimation (by ratios) and calculation of voltages and resistances in series and parallel circuits.
- Determining of potentials, voltage drops and currents in more complex circuits by means of the load/current arrow system.
- Exercises in the calculation of power, work and efficiencies.
- Reading of circuit diagrams, tracing of current paths.

Electrical hazards and first aid

- Reading of circuit diagrams, tracing of current paths,
- Stimulus thresholds,
- Let-go threshold,
- Cardiac fibrillation,
- Burns,
- Duration of the effect of current upon the human body,
- Resistance of the human body,
- Hazardous body currents,
- Maximum touch voltage,
- General information on first aid, behaviour in the event of fire,
- Accidents caused by electric current,
- Measures to be taken in the event of injury,

- First aid in the event of injury caused by electric current,
- Records of first-aid measures,
- Reporting of accidents.

Measures for protection against electric shock and fault arcs

- Classification of protective measures; key terms.
- Protection against direct contact:
 - Protection by the insulation of live parts,
 - Protection by shrouding or encapsulation.
- Protection against direct and indirect contact (extra-low voltage).
- Protection against indirect contact (protection against hazardous electric shock in the event of a fault):
 - Protective insulation,
 - Protective separation,
 - Protection by disconnection:
 - Protective device,
 - Mains systems,
 - Protective measures in the IT system.
- Function of potential equalization.

Requirements and suitable measures

- Protective measures:
 - Overload protective devices,
 - Residual current devices.
- Tests based upon DIN VDE 0100-600:
 - Visual inspection,
 - Measurements of the insulation resistance,
 - Function test.
- Organization and documentation of the tests.

Organization of safety and health for electrical work

- OSH system,
- European legislation (EU Low-voltage Directive),
- German legislation (German occupational safety and health act, German ordinance on industrial safety and health with TRBS),
- Accident prevention regulations: BGV/GUV-A 1 governing principles of prevention, BGV/GUV-A 3, “Electrical installations and equipment”,
- Codes of good practice (DIN, EN, VDE, further standards, e. g. governing measurement),
- Risk assessment,
- Content of the BGV/GUV-V A3 accident prevention regulation, “Electrical installations and equipment”, and of the DIN VDE 0105-100 standard governing measures for accident prevention: the five safety rules,
- Repair, commissioning, maintenance and service,
- Assurance of safety by personal protective equipment and other equipment,
- Informative safety technology, warning signs.

Specialist and man-management responsibility

- Delegated responsibility of managers,
- Responsibility of the skilled electrical person,
- Legal consequences.

Employee qualifications in the area of electrical engineering

- Who is permitted to carry out work on the electrical system?
- Instruction of electrical lay persons, tasking of workers.

Use of HV systems in vehicles

- Introduction to the subject of alternative drives.
- Structure, function and mode of operation of alternative drives
 - Fuel cell vehicles,
 - Hybrid drives,
 - Electric vehicles.
- Fuel cell/hybrid vehicles: concepts and operating modes.
- HV components: e. g. fuel cells, HV batteries, power electronics, DC/DC converters, three-phase, synchronous and asynchronous machines, other safety-critical components.
- Federal ECE Rule 100.
- Motor Vehicle Safety Standard 305 (FMV SS 305).
- Measures to ISO 6469-3 and DIN EN 61140 (VDE 0140-1) for protection against electric shock.
- Recording of energy flows during operation of the hybrid system in various modes.
- Calculation of body currents in the event of insulation faults; hazards of such body currents.
- Risk assessment for fuel cell/hybrid vehicles.
- Protection classes/degrees of protection.
- Determining the R_i of different NiMH cells.
- Placing of hybrid vehicles in the non-live state.
- Measurements on the HV system.
- Replacement of installed components.
- Commissioning with determining of the R_{ISO} of the HV system with/without faults in the HV system.
- Measurements (voltage drop and potential) on high-resistance circuits on conventional vehicles in consideration of the R_i of the instrument.
- Measurement of capacitance and inductance.
- Measurement of pulse width and frequency on conventional vehicles.
- Creation and understanding of circuits for transformation of direct current, with and without galvanic isolation.

- Measurement exercises on hybrid vehicles: location of the components, connection and disconnection of the maintenance plug (service disconnect), checking of isolation, measurement of HV+ against HV- and against the vehicle earth.
- Markings in accordance with vehicle standards/DIN VDE standards/accident prevention regulations.
- Conductors and cables:
 - Cable core arrangements, core and outer insulation,
 - Core markings,
 - Proper electrical connections,
 - Preparation of fine- and ultra-fine-stranded conductors.

Annex 5

Topics covered by training for persons with prior electrical knowledge in the automotive sector

The training must encompass at least 48 teaching periods.

The topics indicated below serve as an example only and reflect the current state of the art of automotive HV technology. Topics irrelevant to the work to be carried out can be ignored. Other relevant topics must be added in their place if necessary.

Electrical hazards and first aid

- Effects upon the human body,
- Stimulus thresholds,
- Let-go threshold,
- Cardiac fibrillation,
- Burns,
- Duration of the effect of current upon the human body,
- Resistance of the human body,
- Hazardous body currents,
- Maximum touch voltage,
- General information on first aid, behaviour in the event of fire,
- Accidents caused by electric current,
- Measures to be taken in the event of injury,
- First aid in the event of injury caused by electric current,
- Records of first-aid measures,
- Reporting of accidents.

Measures for protection against electric shock and fault arcs

- Classification of protective measures; key terms.
- Protection against direct contact:
 - Protection by the insulation of live parts,
 - Protection by shrouding or encapsulation.
- Protection against direct and indirect contact (extra-low voltage).

- Protection against indirect contact (protection against hazardous electric shock in the event of a fault)
 - Protective insulation,
 - Protective separation,
 - Protection by disconnection:
 - Protective device,
 - Mains systems,
 - Protective measures in the IT system.
- Function of potential equalization.

Requirements and suitable measures

- Protective measures:
 - Overload protective devices,
 - Residual-current devices.
- Tests based upon DIN VDE 0100-600:
 - Visual inspection,
 - Measurements of the insulation resistance,
 - Function test.
- Organization and documentation of the tests.

Organization and documentation of the tests

- OSH system,
- European legislation (EU Low-voltage Directive),
- German legislation (German occupational safety and health act, German ordinance on industrial safety and health with TRBS),
- Accident prevention regulations: BGV/GUV-A1 governing principles of prevention, BGV/GUV-A 3, “Electrical installations and equipment”),
- Codes of good practice (DIN, EN, VDE, further standards, e. g. governing measurement),
- Risk assessment,

- Content of the BGV/GUV-V A3 accident prevention regulation, “Electrical installations and equipment”, and of the DIN VDE 0105-100 standard governing measures for accident prevention: the five safety rules,
- Repair, commissioning, maintenance and service,
- Assurance of safety by personal protective equipment and other equipment,
- Informative safety technology, warning signs.

Specialist and man-management responsibility

- Delegated responsibility of managers,
- Responsibility of the skilled electrical person,
- Legal consequences.

Employee qualifications in the area of electrical engineering

- Who is permitted to carry out work on the electrical system?
- Instruction of electrical lay persons, tasking of workers.

Use of HV systems in vehicles

- Introduction to the subject of alternative drives,
- Structure, function and mode of operation of alternative drives:
 - Fuel cell vehicles,
 - Hybrid drives,
 - Electric vehicles.
- Fuel cell/hybrid vehicles: concepts and operating modes,
- HV components: e. g. fuel cells, HV batteries, power electronics, DC/DC converters, three-phase, synchronous and asynchronous machines, other safety-critical components,
- Federal ECE Rule 100,
- Measures to ISO 6469-3 and DIN EN 61140 (VDE 0140-1) for protection against electric shock,
- Motor Vehicle Safety Standard 305 (FMVSS 305),
- Recording of energy flows during operation of the hybrid system in various modes,

- Calculation of body currents in the event of insulation faults; hazards of such body currents,
- Risk assessment for fuel cell/hybrid vehicles,
- Protection classes/degrees of protection,
- Determining the R_i of different NiMH cells,
- Placing of hybrid vehicles in the non-live state,
- Measurements on the HV system,
- Replacement of installed components,
- Commissioning with determining of the R_{ISO} of the HV system with/without faults in the HV system,
- Measurements (voltage drop and potential) on high-resistance circuits on conventional vehicles in consideration of the R_i of the instrument,
- Measurement of capacitance and inductance,
- Measurement of pulse width and frequency on conventional vehicles,
- Creation and understanding of circuits for transformation of direct current, with and without galvanic isolation,
- Measurement exercises on hybrid vehicles: location of the components, connection and disconnection of the maintenance plug (service disconnect), checking of isolation, measurement of HV + against HV- and against the vehicle earth,
- Markings in accordance with vehicle standards/DIN VDE standards/accident prevention regulations,
- Conductors and cables:
 - Cable core arrangements, core and outer insulation,
 - Core markings,
 - Proper electrical connections,
 - Preparation of fine- and ultra-fine-stranded conductors.

Annex 6

Topics covered by training for skilled electrical persons in the low-voltage sector

The topics indicated below serve as an example only and reflect the current state of the art of automotive HV technology. Topics irrelevant to the work to be carried out can be ignored. Other relevant topics must be added in their place if necessary.

The following topics must be adapted to the current level of knowledge of the participants.

- Design and function of vehicle electrical systems,
- Introduction to the subject of alternative drives,
- Structure, function and mode of operation of alternative drives:
 - Fuel cell vehicles,
 - Hybrid drives,
 - Electric vehicles.
- Fuel cell/hybrid vehicles: concepts and operating modes,
- HV components: e. g. fuel cells, HV batteries, power electronics, DC/DC converters, three-phase, synchronous and asynchronous machines, other safety-critical components,
- Federal ECE Rule 100,
- Measures to ISO 6469-3 and DIN EN 61140 (VDE 0140-1) for protection against electric shock,
- Motor Vehicle Safety Standard 305 (FMVSS 305),
- Recording of energy flows during operation of the hybrid system in various modes,
- Calculation of body currents in the event of insulation faults; hazards of such body currents,
- Risk assessment for fuel cell/hybrid vehicles,
- Protection classes/degrees of protection,
- Determining the R_i of different NiMH cells,
- Placing of hybrid vehicles in the non-live state,
- Measurements on the HV system,
- Replacement of installed components,
- Commissioning with determining of the R_{iso} of the HV system with/without faults in the HV system,

- Measurements (voltage drop and potential) on high-resistance circuits on conventional vehicles in consideration of the R_i of the instrument,
- Measurement of capacitance and inductance,
- Measurement of pulse width and frequency on conventional vehicles,
- Creation and understanding of circuits for transformation of direct current, with and without galvanic isolation,
- Measurement exercises on hybrid vehicles: location of the components, connection and disconnection of the maintenance plug (service disconnect), checking of isolation, measurement of HV + against HV- and against the vehicle earth,
- Markings in accordance with vehicle standards/DIN VDE standards/accident prevention.

Annex 7

Flow chart: need for training for service work on vehicles with intrinsically safe HV systems

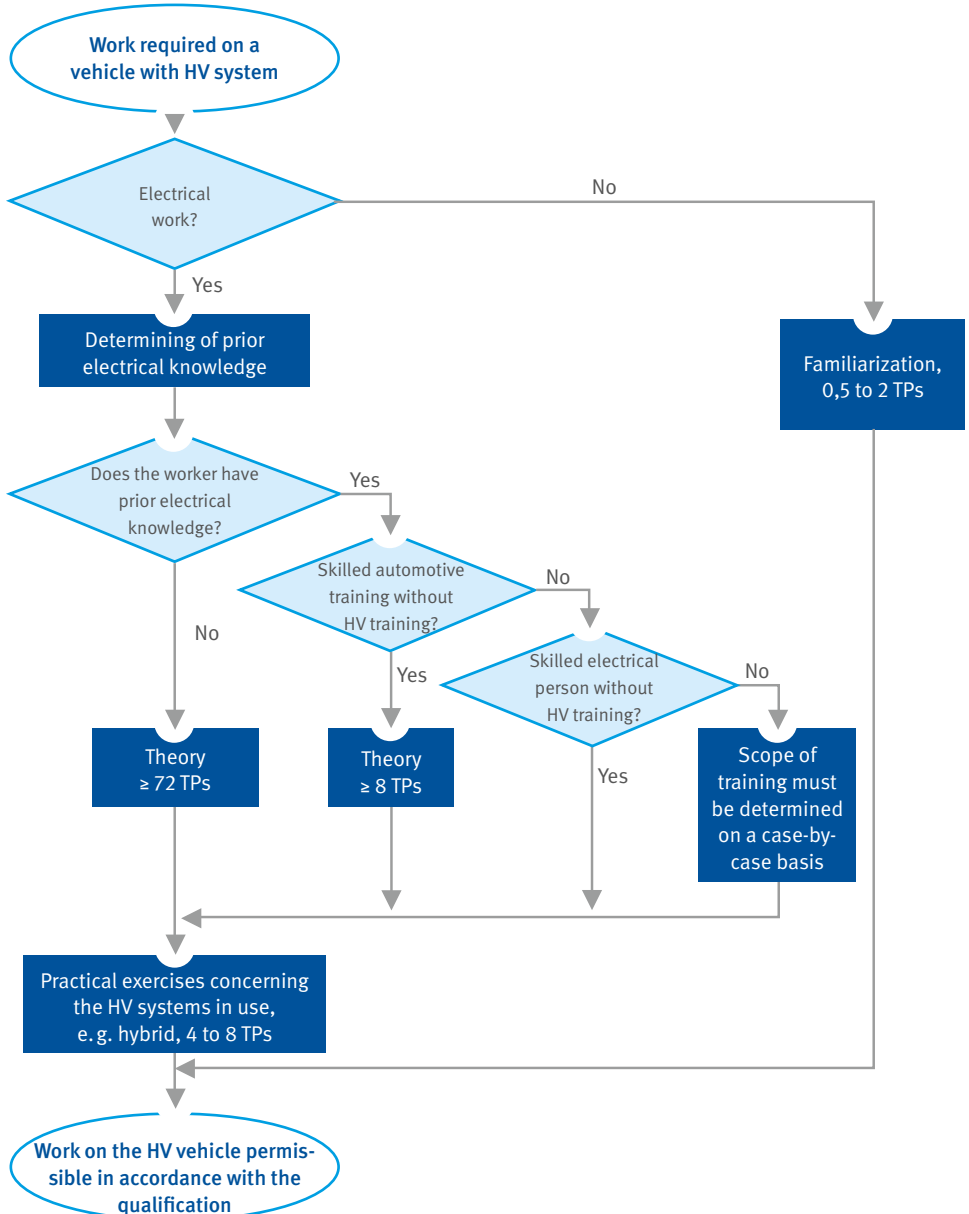

Annex 8

Topics covered by training for persons with prior electrical knowledge in the automotive sector for work in service workshops on vehicles with intrinsically safe HV systems

The topics indicated below serve as an example only and reflect the current state of the art of automotive HV technology. Depending upon the work to be carried out, topics that are not required can be ignored. Other relevant topics must be added in their place if necessary.

Technical responsibility

- Legal consequences
(What am I allowed to do? What happens in the event of abuse? No live work!),
- Control and supervision by a skilled electrical person.

Electrical hazards and first aid

- Effects upon the human body,
- Stimulus thresholds,
- Let-go threshold,
- Cardiac fibrillation,
- Burns,
- Duration of the effect of current upon the human body,
- Resistance of the human body,
- Hazardous body currents,
- Maximum touch voltage,
- General information on first aid, behaviour in the event of fire,
- Accidents caused by electric current,
- Measures to be taken in the event of injury,
- First aid in the event of injury caused by electric current,
- Records of first-aid measures,
- Reporting of accidents.

Measures for protection against electric shock and fault arcs

- Classification of protective measures; key terms,
- Protection against direct contact:
 - Protection by the insulation of live parts,

- Protection by shrouding or encapsulation.
- Protection against direct and indirect contact (extra-low voltage),
- Protection against indirect contact (protection against hazardous electric shock in the event of a fault):
 - Protective insulation,
 - Protective separation,
 - Protection by disconnection:
 - Protective device,
 - Electrical system types,
 - Protective measures in the IT system.
- Function of potential equalization,
- Testing of the protective measures,
- Testing of the dielectric strength, for example by on-board or external diagnostics systems,
- Visual inspection,
- Checking of the labelling.

Electrical installations and equipment in accordance with the BGV/GUV-V A3 accident prevention regulation and with DIN VDE 0105-100

- Risk assessment for work on HV vehicles in support of the employer,
- Content of accident prevention regulation BGV/GUV-V A3, “Electrical installations and equipment”, and of the DIN VDE 0105-100 standard governing measures for accident prevention: the first three of the five safety rules
 - Disconnect the HV system,
 - Safeguard against reconnection,
 - Verify the non-live state.
- Repair, commissioning, maintenance and service – definition of the terms,
- Measures for troubleshooting on live parts, for example by on-board or external diagnostics systems,
- Familiarity with possible personal protective equipment and other equipment,
- Informative safety technology, warning signs.

HV concept and vehicle engineering

- Introduction to the subject of alternative drives,
- Structure, function and mode of operation of alternative drives,
- Definition of HV vehicle, explanation of “vehicle with intrinsically safe HV system“,
- HV batteries, power electronics, DC/DC converters, three-phase, synchronous and asynchronous machines, other HV components,
- Fuel cell vehicles,
- Hybridantriebe,
- Electric vehicles.

Allgemeines praktisches Vorgehen

- HV-System spannungsfrei schalten,
- Hybrid drives,
- Spannungsfreiheit feststellen.

Annex 9

Flow chart: need for training for service work on vehicles with non-intrinsically safe HV systems

Persons already qualified for work on intrinsically safe HV systems are not considered in the following flow chart.

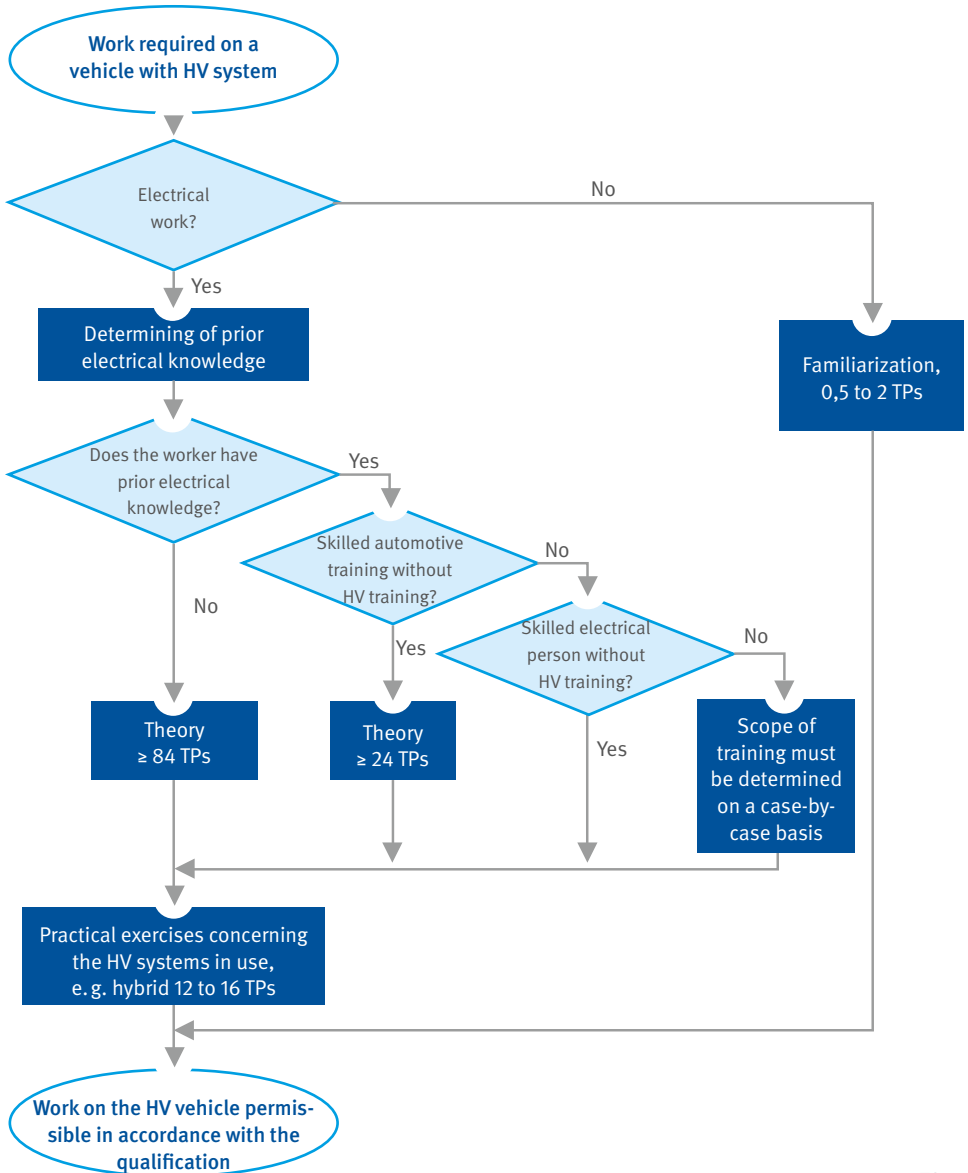

Annex 10

Model certificate of attendance for persons who have received electrical instruction in inherently safe automotive HV systems

Mr John Smith

E-Mobility Car Dealer, 17 Any Street, Anytown

attended the following training course comprising (number) _____ teaching periods on (date) _____

Person who has received electrical instruction on intrinsically safe automotive HV systems

The participant received instruction from an “expert in work on intrinsically safe HV systems in automotive service workshops“ in the work with which he or she is tasked, in the possible hazards in the event of improper behaviour and in the necessary protective equipment and protective measures.

Subject of the training in accordance with informative document BGI/GUV-I 8686:

- Definition of an intrinsically safe vehicle,
- Marking of high-voltage components,
- Operation of vehicles and the associated equipment (e.g. test rigs),
- Performance of general tasks which do not require isolation of the HV system,
- Performance of all mechanical tasks on the vehicle (but: “don’t touch orange!“),
- Impermissible work on the vehicle,
- Isolation as an additional safety measure,
- Appointment of the individual to be consulted in the event of uncertainty,
- Organization of procedures for electrical work to be performed by persons who have received electrical instruction under the control and supervision of a skilled electrical person for HV systems.

The participant understood the material: _____

Party responsible for training: _____

_____ (place) _____

Training course

*Teaching periods (equivalent to 45 minutes)

Annex 11

Model certificate for an expert in automotive high-voltage (HV) systems for work in service workshops on vehicles with intrinsically safe HV systems

Mr John Smith

E-Mobility Dealership, 17 Anystreet, Anytown

attended the above training course from (date) _____ to (date) _____

Expert in automotive high-voltage (HV) systems for work in service workshops on vehicles with intrinsically safe HV systems

The participant followed the course of training and passed the examination.

The participant satisfies the primary conditions for successful participation by virtue of his or her comprehensive basic electrical knowledge obtained through his or her initial and further training in the automotive sector and demonstrated in a preliminary test.

Topics to be taught (can also be stated on the reverse):	TP*
Electrical hazards, behaviour in the event of electrical accidents and first aid	
Measures for protection against electric shock and fault arcs	
Electrical work in accordance with BGV/GUV-V A3, DIN VDE 0105-100 and BGI/GUV-I 8686	
Specialist and man-management responsibility, legal principles	
HV concept and vehicle technology (vehicle with intrinsically safe HV system, technology employed in HV vehicles: three-phase motors, DC/DC converters, DC/AC converters, etc.)	
HV concepts with reference to examples of specific vehicles	
.....	
Practical exercises: Electrical isolation, verification and documentation of the non-live state on the following HV systems: <i>Enter the specific HV systems here on which practical training was performed, e.g. manufacture, type,,,</i>	
Total scope of training	

*Teaching periods (equivalent to 45 minutes)

This training measure equips the employee to work independently and safely on vehicles with intrinsically safe HV systems. Such work includes application of the five safety rules, the replacement of HV components such as air-conditioning components and oil pumps in the non-live state, and troubleshooting on non-exposed HV components including the use of test adapters proof against shock hazards. The participant is able to assess the work with which her or she is tasked, to recognize possible hazards, and to take the protective measures necessary for the HV system concerned.

This training measure satisfies the minimum requirements of the BGI/GUV-I 8686 informative document.

Party responsible: _____

_____ (place) _____

Training course

Regulations, codes, literature

1. **Statutes, regulations, technical rules**

Available from:

Bookshops, the Internet: e. g. www.gesetze-im-internet.de

German occupational safety and health act

German ordinance on industrial safety and health

TRBS technical rules for industrial safety and health

2. **Occupational safety and health regulations, rules and informative documents**

Available from:

Your responsible accident insurance institution

or from www.dguv.de/publikationen.

Accident prevention regulations:

“Governing principles of prevention“ (BGV/GUV-V A1; also available in english)

“Electrical installations and equipment“ (BGV/GUV-V A3; also available in english)

Informative documents

“Governing skilled electrical persons“ (BGI 548; only available in german)

„Governing the erection and operation of electrical test systems“ (BGI 891; only available in german)

3. Standards/VDE provisions

Available from:
Beuth-Verlag GmbH,
Burggrafenstrasse 6, 10787 Berlin
or
VDE-Verlag,
Bismarckstrasse 33, 10625 Berlin

DIN EN 60529 (VDE 0470-1)	“Degrees of protection provided by enclosures (IP code)“
DIN VDE 0682-401	„Voltage detectors Part 3: Two-pole low-voltage type“
DIN VDE 0105-100	„Operation of electrical installations“
DIN VDE 1000-10	„Requirements for persons working in a field of electrical engineering“
DIN VDE 0100-600	„Low voltage electrical installations – Part 6: Verification“
ISO 6469-3	„Electrically propelled road vehicles – Safety specifications“ - Part 3: „Protection of persons against electric shock“
DIN EN 61140 (VDE 0140-1)	Common aspects for installation and equipment
DIN EN 50191 (VDE 0104)	„Erection and operation of electrical test equipment“
Federal ECE Rule 100	Regulation No 100 of the Economic Commission for Europe of the United Nations (UN/ECE) – Uniform provisions concerning the approval of vehicles with regard to specific requirements for the electric power train.

4. Literature

Motor Vehicle Safety Standard 305 (FMVSS 305) “LABORATORY TEST PROCEDURE FOR ELECTRIC POWERED VEHICLES: ELECTROLYTE SPILLAGE AND ELECTRICAL SHOCK PROTECTION” U.S. DEPARTMENT OF TRANSPORTATION, NATIONAL HIGHWAY TRAFFIC SAFETY ADMINISTRATION

Authors

Dr. Joachim Dreyer

German Social Accident Insurance Institution for the administrative sector

Albert Först

German Social Accident Insurance Institution for woodworking and metalworking industries

Wolfgang Pechoc

German Social Accident Insurance Institution for the energy, textile, electrical and media products sectors

Thomas Seifert

German Social Accident Insurance Institution for the transport industry

René Stieper

German Social Accident Insurance Institution for woodworking and metalworking industries

List of illustrations

Title	©iStock, Alexey Dudoladov; Arkadi Bojaršinov	1
Image:		
Figure 1:	Service plug	12
Figure 2:	Examples of safeguarding against reconnection	12
Figure 3:	“Verification of the non-live state“	13
Figure 4:	Example of equipping with practical skills in the handling of HV systems.....	16
Figure 5:	Basic protection by isolation and shrouding.....	22
Figure 6:	Marking of HV vehicles in the workshop	24
Figure 7:	Example of safe disconnection by technical means for the removal of shrouds by means of pilot contact	48
Figure 8:	Example of safeguarding of the working area during testing work	49
Figure 9:	Example of the marking of HV components	51

**Deutsche Gesetzliche
Unfallversicherung (DGUV)**

Glinkastraße 40
10117 Berlin
Tel.: 030 288763800
Fax: 030 288763808
E-Mail: info@dguv.de
Internet: www.dguv.de